

— COMSYS —
PERFECTING POWER

| ADF

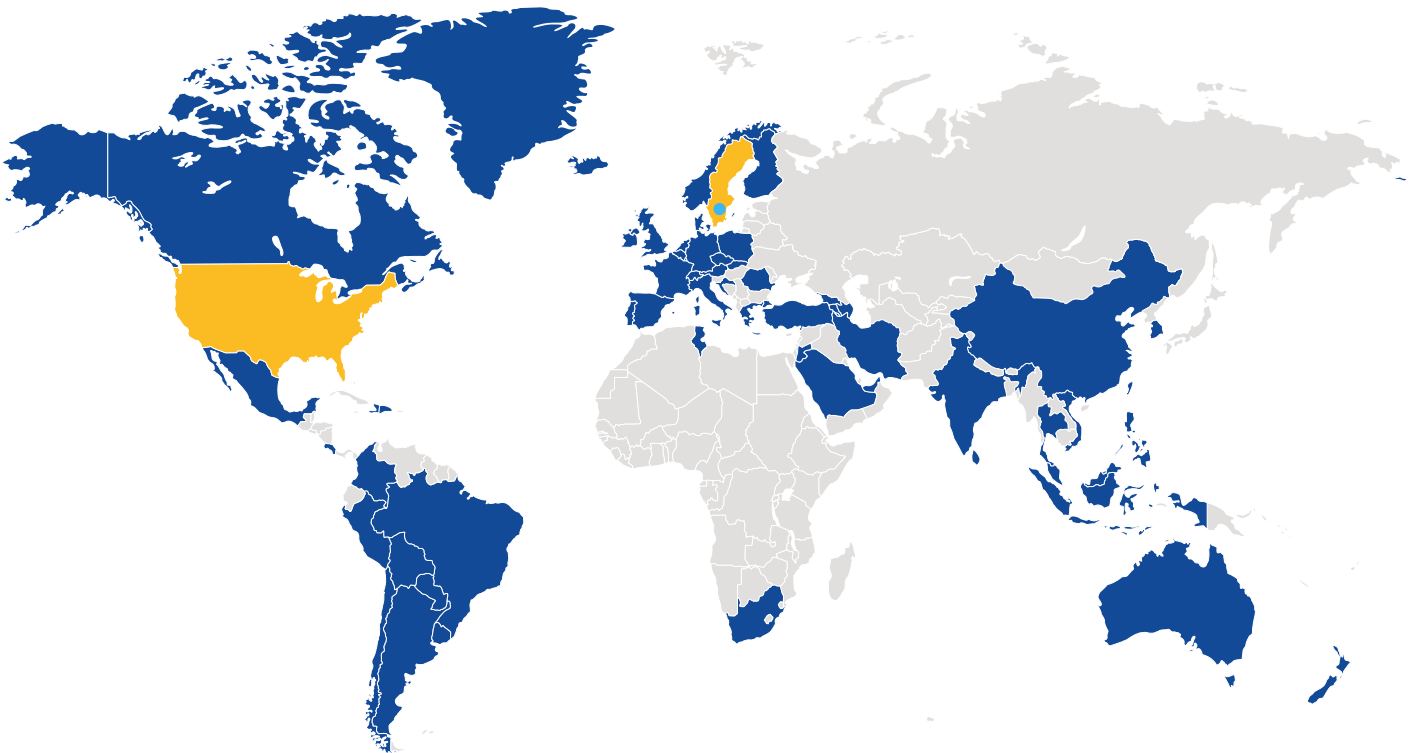

ADF technology makes energy more efficient among our 5 000 installations around the globe and has been established as THE standard within Active filtering because of its many unique features that adds value to customer sites.



 Comsys Head Office, Sweden  Comsys Partner  Production Sites, located in Sweden and in the US

MOST INDUSTRIES HAVE THOUSANDS ELECTRICAL DRIVES IN CRITICAL EQUIPMENT

THEIR SPEED INCREASES & DECREASES
CONTINUOUSLY

THIS CREATES DISTURBANCES

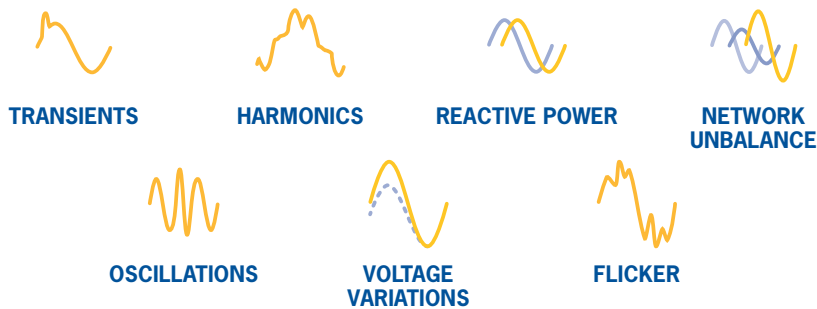

Causing a variety of

PROBLEMS

OVERHEATING TRANSFORMERS
SHORTER EQUIPMENT LIFE
NUISANCE TRIPPING IN CIRCUIT BREAKERS
PRODUCTION FAILURE/DOWNTIME
NON-COMPLIANCE
EXCEEDING NORM LIMITS

Low harmonic drive technology

If you have a number of drives (also referred to as variable-speed motor drives) on site, you are generating electrical disturbances.



LHD
= standard 6-pulse drive
+ filter technology

These disturbances include network unbalance, flicker, and especially harmonics—not to mention the risk of regulatory non-compliance. Those working in the marine, offshore, and water treatment industries are especially vulnerable to these problems.

For decades the common filter solution has been passive filter, but there's a modern solution that offers an improved competitive advantage. With active filter technology, you get a more compact solution that enables fewer losses and less total harmonic distortion (THD).

ADF is the most flexible system available to help you achieve an LHD. And there's no comparison when it comes to price: ADF can save you up to 40%* in total cost of ownership compared to AFE. It's a versatile yet powerful solution that takes the hassle out of installation and operation.

* based on internal calculation

USE OUR COMPONENTS TO YOUR ADVANTAGE

Because ADF components can be combined with a drive to create the ultimate low harmonic solution, it's ideal for system integrators or OEMs (original equipment manufacturers). We can give you the components you need to succeed in any application.

Read on to learn what makes ADF technology the smart choice for your operation.



Technology that makes energy more efficient

Engineered in Sweden, ADF provides a unique way of reducing energy losses in a vast range of applications such as industrial production machines and generator systems.

It works by sensing electrical behavior, then reduces energy losses by correcting the electrical behavior. This is achieved by using state-of-the-art signal processing and advanced control structures to manage the power flow to and from the machine with a power processor (power converter). By continuously monitoring the network and injecting exactly the right amount of compensation current – at exactly the right time – the most efficient and accurate solution to any power quality problem can be achieved.



LOAD CURRENT

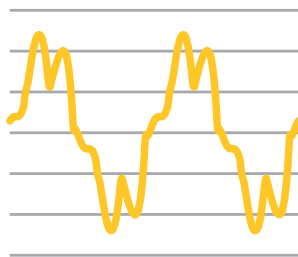

+

ADF COMPENSATION CURRENT

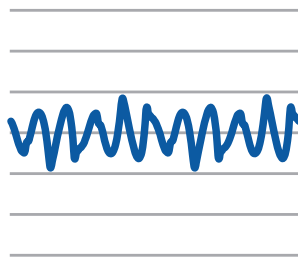

=

LINE CURRENT

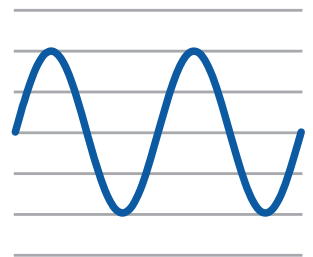

ADF vs. Competitor

Compared to other power quality technologies, ADF provides a solution that is hard to beat. It is an efficient system that leads to low losses, but more than that, it provides a reliable tool box that can seamlessly address a variety of disturbances, from THD to flicker.

And while most power quality products can help you meet regulations in some sense, we do that with a lighter, more compact solution. The modular structure of ADF also allows for flexibility for the future and adaptability for your specific project.

	ADF	MULTIPULSE	AFE	PASSIVE FILTER
Losses	●	●	●	●
Total harmonic distortion	●	●	●	●
Physical size	●	●	●	●

● LOW ● MEDIUM ● HIGH

	ADF	MULTIPULSE	AFE	PASSIVE FILTER
Meets regulation *	●	◐	●	○
Specified harmonic selection	●	○	○	○
Resonance elimination	●	○	○	○
Flicker Compensation	●	○	○	○
Configurable	●	○	◐	○

Although other solutions will meet some of your needs, you can rely on ADF to meet all of them.

* IEEE519, G5/4, EN61000, etc

What to expect with ADF

An ADF unit is basically a very advanced computer-controlled current generator with the ability to instantly produce any shape or form of compensation current.

A simplified diagram of the operating principle is shown in the figure below. Each ADF unit is connected in parallel, in shunt, with the load that requires compensation. The power flows of electrical currents between the load and the network are measured and analyzed [1] to determine if disturbances such as reactive displacement and/or harmonics are present.

If found, the ADF unit injects compensation current [2] that are the exact opposite of, for example, the harmonics and/or reactive displacement. This is done in order to cancel out the load behavior [3].

The result is an ideal load with a minimum of power losses and disturbances. The energy profile then appears ideal to the transformer.

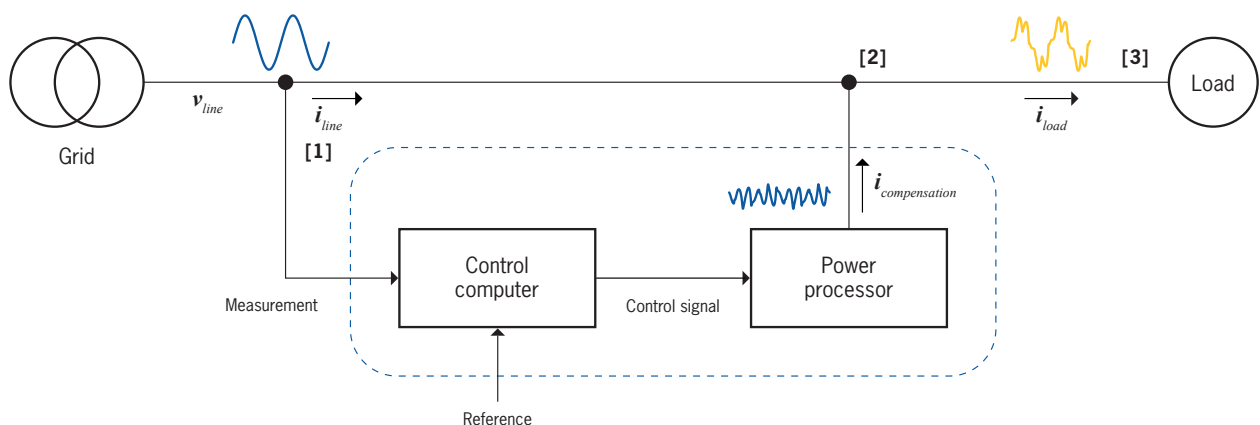

ADF TECHNOLOGY HELPS YOU SAVE:

1 SPACE

Since one module supports multiple drives, you can save space and ensure flexibility for the future.

2 MONEY

Increase energy efficiency while reducing the expense of replacing worn equipment.

3 TIME

Avoid unnecessary downtime for maintenance or replacement of equipment affected by power quality issues.

4 HASSLE

ADF-type technology is already being included in regulatory demands and equipment warranties – a trend that will only continue to grow.

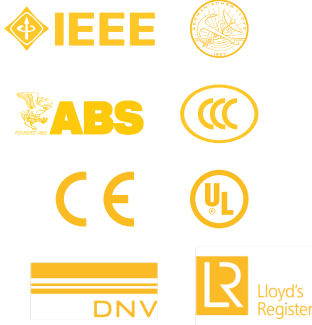

SECURING REGULATORY COMPLIANCE

When it comes to regulatory compliance, you need a solution you can depend on. But more than that, why not consider a solution that leaves room for growth? With ADF, you can remain care-free in the knowledge that this low harmonic solution will ensure you meet necessary standards.

See some examples here on the left.

MAINTAIN YOUR EQUIPMENT WARRANTIES

With increasingly sensitive equipment, come stricter technical infrastructure demands and increasing electrical disturbances. Avoid this concern over loss of warranties with a stable and reliable power quality solution.

EXTEND YOUR EQUIPMENT LIFETIME

A reliable power quality solution ensures that unstable power is compensated. With ADF, you lower the risk for wear, expensive shutdowns, and replacement.

The ADF range

Within the ADF, we have a modular collection with a small set of components. With a short list of spare parts, our liquid cooling and air cooling capabilities, and a full voltage range, you get a high degree of reliability and flexibility.

ADF P25

The ADF P25 active filter gives you everything in a compact format. Although compact and cost-effective, the ADF P25 features the same excellent cutting-edge performance as its bigger family members.

[30 A]

Like its bigger brothers, the ADF P25 is ultra-efficient and easy to use. The compact design allows the ADF P25 to be used in applications where space is at a premium. The ADF P25 has a nominal compensation current of 30 A (three wire, 415 V).

The ADF P25 can be commissioned using the Web User Interface (WUI) called ADF Dashboard. No special software needs to be installed on the laptop to perform commissioning.

SOME TYPICAL APPLICATIONS INCLUDE

- Drive systems
- Industrial loads
- Pump applications
- UPS systems
- Offices and commercial buildings
- Fans
- Medical equipment

CONTROL FEATURES

- Fully customizable harmonic compensation
- Several ADF P25s can be combined for higher power
- Insensitive to network conditions
- Idle mode during low load (Standby)
- Non-overloadable
- Fast response time
- ADF Dashboard WUI (Web User Interface)
- Floating grid frequency support



ADF P100

ADF P100 active filters give you the compensation capabilities you need in a compact format.

It's small and cost-effective, but the ADF P100 features the cutting-edge performance you can expect with ADF.

[50–150 A]

The ADF P100 is ultra-efficient and easy to use. The wall-mounted cabinet is a cost-effective package that allows the use of ADF technology in applications where saving space and weight are optimal. Several ADF P100 units can be used in parallel, and the ADF P100 can also be used in Sensorless operation for harmonics compensation. The ADF P100 is available in three-wire versions (50–150 A) and in a four-wire version – the ADF P100N (100 A, 300 A Neutral).

SOME TYPICAL APPLICATIONS INCLUDE

- Maritime vessels
- Offshore oil rigs
- Drive systems
- Data centers
- Pump applications
- Medical equipment
- Industrial loads
- UPS systems
- HVAC

CONTROL FEATURES

- Fully customizable harmonic compensation
- Several ADF P100s can be combined for higher power
- Insensitive to network conditions
- Idle mode during low load (Standby)
- Non-overloadable
- Fast response time
- ADF Dashboard WUI (Web User Interface)
- Floating grid frequency support



ADF P200

The ADF P200 is the powerhouse you need when all else fails. It reads faster and corrects faster than other solutions, but its true specialty is eliminating resonances and mitigating interharmonics where other solutions simply can't.

[120 A]

The ADF P200 is a compact, wall-mounted product and is highly specialized and compatible with all three-phase low-voltage applications. The ADF P200 can be installed into the ADF P300 as well as be deployed in system integration projects. It is ideal for eliminating resonances both in current control and Sensorless operation, as well as for mitigating interharmonics.

SOME TYPICAL APPLICATIONS INCLUDE

- Offices and commercial buildings
- Small- and medium-sized manufacturing companies
- Fluorescent lamps
- Medical equipment
- Industrial loads
- UPS systems
- Fans
- Drive systems
- HVAC

CONTROL FEATURES

- Fully customizable harmonic compensation
- Compensates supraharmonics up to 5kHz
- Several ADF P200 units can be combined for higher power
- Insensitive to network conditions
- Cannot be overloaded
- Fastest response time in the industry

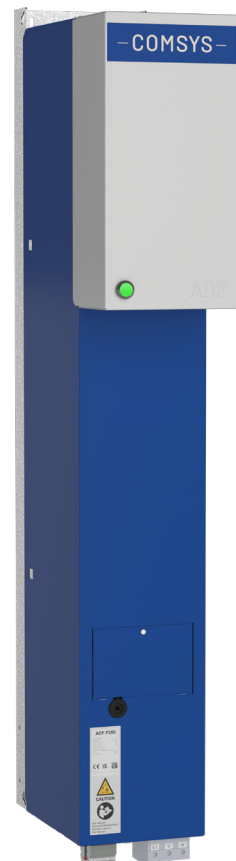

ADF P300

The ADF P300 is the ideal active filter for small and medium size commercial and industrial loads. It is a versatile solution and the best choice for most applications because it is such a flexible active filter.

[50–450 A]

With the ADF P300, the state-of-the-art performance of our active filter technology comes encased in a compact cabinet, although larger than the ADF P100. Each ADF P300 system is delivered with 50–450 A optimization power and the modular design makes it easy and convenient to add future upgrades. The modularity also ensures superior scalability—up to 15 units can be used in parallel.

The ADF P300 is compatible with all three-phase low voltage applications. Beyond harmonics and reactive compensation, the ADF P300 can also be used for flicker control, harmonics with Sensorless operation, and load balancing. The ADF P300 can also be tailored to unique applications requiring special optimization.

SOME TYPICAL APPLICATIONS INCLUDE

- Small and medium sized manufacturing companies
- Fluorescent lamps
- Medical equipment
- Industrial loads
- Offices and commercial buildings
- UPS systems
- Fans
- Drive systems
- Maritime vessels
- Offshore oil rigs
- HVAC



HCAI

Seismic Certification Approval

#OSP-0718*



ADF P300 meets the most stringent earthquake requirements according to GR63 Core

CONTROL FEATURES

- Fully customizable harmonic compensation
- Several ADF P300s can be combined for higher power
- Insensitive to network conditions
- Idle mode during low load (Standby)
- Cannot be overloaded
- Fast response time
- ADF Dashboard WUI (Web User Interface)



*The certification is applicable only to ADF P300 G3 UL-version.

PPM300

The ADF PPM300 inverter module is one of the key components of the ADF System Integration Program. Designed for easy integration into electrical cabinets and motor control centers, this component enables you to build your own active harmonic filter or low harmonic solution.

[50–150 A]

Join our System Integration program when you need to develop a custom solution – either as a System Integrator or OEM. The flexible building blocks allow you to integrate the ADF technology into your application in the most flexible way.

Building on a history of successful installations, the ADF PPM300 tolerates high levels of frequency disturbances and continues to compensate reliably in applications where passive filters are likely to break down. ADF PPM300 is available with air or liquid-cooling.

The ADF “building blocks” can be used to build harmonic compensation solutions, from small to large. From a single PPM system with a single control unit, up to a 90-unit PPM system with 15 control units.

SOME TYPICAL APPLICATIONS INCLUDE

- Custom low harmonic drive systems
- Custom cabinets
- Liquid cooling applications
- Marine Applications
- Machine builders
- Utilities
- STATCOM
- OEM

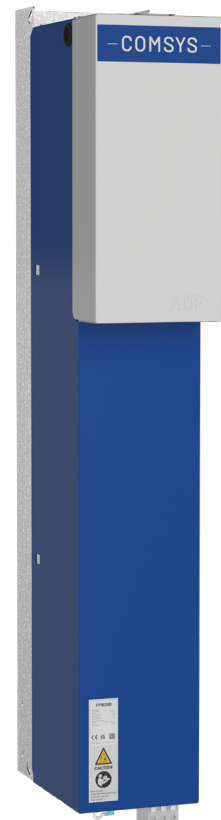

System integration

The ADF system integration program is a unique concept to customize and integrate ADF components, or what we can refer to as building blocks, in your projects and products.

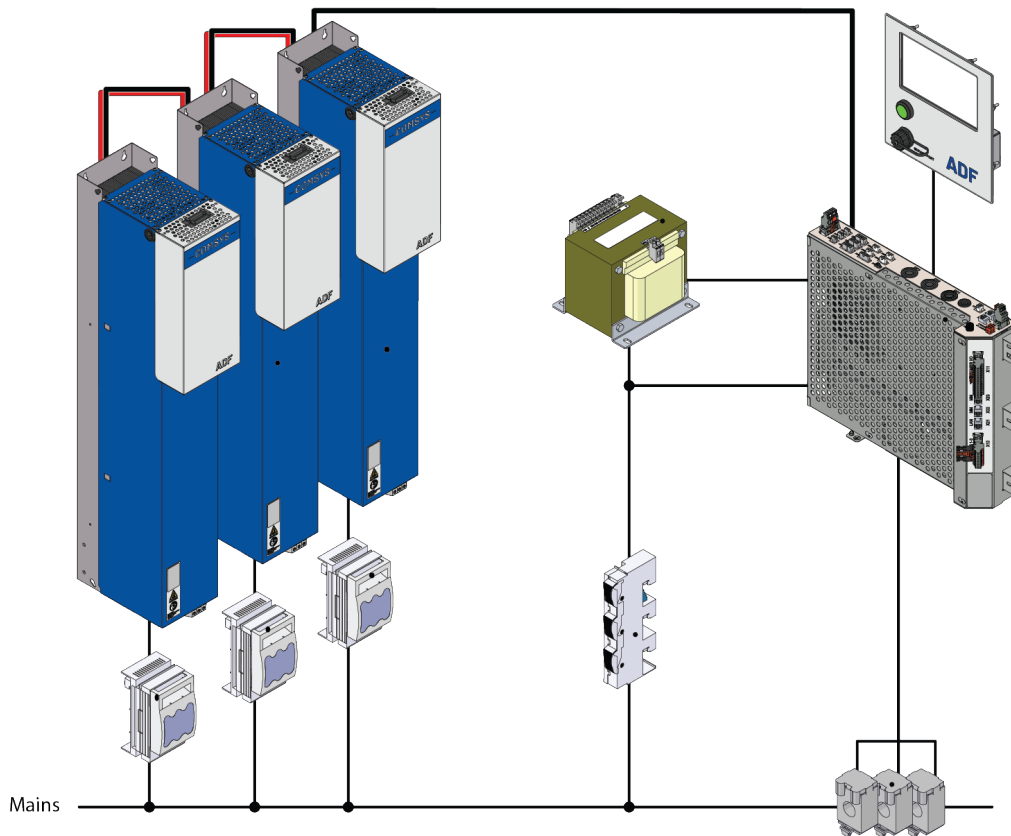

Our “building blocks” include the PPM 300 inverter module, the control unit CM-CAB, and other internal components that enable you to get a complex, functioning, and integrated system quickly. For those who want to utilize existing manufacturing resources, system integration is the smart choice for you.

LHD
= standard 6-pulse drive
+ filter technology

With system integration, your up-front cost is reduced by utilizing our small set of standardized building blocks – making it the most cost-efficient way of integrating ADF into your operation. Additionally, the modularity and flexibility of these building blocks offer unprecedented flexibility and adaptability to any application, from renewable energy production to data centers. This in turn allows you to solve a wide range of problems with a minimal tool set.

With system integration, you can leverage the capabilities built into our standard products by using our building blocks (components).



WITH SYSTEM INTEGRATION, YOU GET:

1

A more compact solution than standalone products.

2

Leading ADF Technology integrated into your existing products.

3

Fast and simple commissioning with the ADF WUI Dashboard

4

Access to the ADF System Integration Program training with ADF Academy

HOW CUSTOMIZABLE IS IT?

- Compensation power ranges from about 30 A to in excess of 10,000 A
- Can be controlled via HMI-4 devices, via web user interface (WUI), or remote controlled via field bus
- Availability in both voltage ranges (< 480 V and 480 – 690 V)
- Available as air-cooled or liquid-cooled

With system integration, you get a power quality solution perfectly adapted to you. Add reduced maintenance costs due to small set of components, and you get a highly efficient, highly flexible solution.

STATCOM systems in electricity networks



ADF STATCOM installation at the Fortum wind farm in Kville, Sweden.

The ADF P700 STATCOM is a high power, utility grade, medium voltage STATCOM for heavy industrial loads. It is ideal for dynamic reactive compensation, flicker mitigation, and harmonic suppression in applications such as electric arc furnaces (EAFs), cranes, hoists and wind farms. In industries with such a high power demand, there is a concurrent need for a powerful power quality solution. That's when you need the STATCOM. ADF P700 STATCOMs can be integrated into existing on-site structures or can be commissioned with their own housing.



ADF product comparison

Our products solve a variety of problems and are suitable for a range of industries. Explore this comparison chart and see which product might be right for your operation.

KEY FEATURE	ADF P25	ADF P100	ADF P200	ADF P300	PPM300	ADF P700 STATCOM
Compact, wall mounted	●	●	●		●	
Harmonics Compensation	●	●	●	●	●	●
Reactive power compensation	●	●	●	●	●	●
Eliminates resonances			●			
Interharmonics compensation			●			
Flicker compensation	●	●		●	●	●
Load balancing	●	●		●	●	●
Medium voltage applications				●	●	●
Available with liquid cooling					●	●
Four-wire version		●				
Voltage range	208-415 V	208-690 V	208-440 V	208-690 V	208-690 V	Up to 136 kV
Industrial	●	●	●	●	●	●
Commercial	●	●	●	●	●	
Utility			●	●	●	●
Marine, offshore	●	●		●	●	
Sensor-less control	●	●	●	●	●	●

*Vedi le specifiche tecniche complete alle pagine 24-25

Added features to boost your performance



Global service network and support

With the ADF Partner Network, you get access to our global service network. Regionally, ADF partners manage commissioning, service, and local support, but these local teams are backed by our centralized support team for more advanced cases.

MAINTENANCE AROUND THE WORLD

In addition to our commissioning service, we also provide service contracts and product maintenance around the world. But we can also use the remote operation capabilities as part of our WUI to conduct quick initial assessments off-site.

Whether you are a customer or a partner within our network, to help you get the most out of ADF products, we also provide hands-on training as part of a program called ADF Academy. No matter where you are in the world, which application you are working with, or where you are in your implementation, we offer these courses to enable you and your team to gain confidence and expertise.

**NO CTs
necessary**

The only solution with Sensorless Control

When you need a retrofit solution or you have a complicated set-up, it can be very difficult to add the CTs (current transformers). But with Sensorless Control, we can compensate without it – so you can eliminate the CTs altogether. This gives you more flexibility when it comes to where and how to install the ADF unit and reduces the overall hassle of installation and compensation. In addition to this, you are also able to isolate sub-grids and compensate background distortion, which further improves the flexibility and adaptability of the ADF platform.

Sensorless Control is now available on all ADF products.

Remote operation works for you

The WUI is a web application requiring no additional software installation. It offers a convenient, easy-to-use service to enable you to monitor your ADF modules from any device – anywhere, anytime. Additionally, the WUI can be integrated into a larger system (i.e. with multiple generators, many loads, etc.), which you can then choose to run on a certain schedule or operation mode. And if your operation uses a PLC, the PLC can read out critical data from the ADF module automatically.

The WUI also allows us to make commissioning faster and easier for you by allowing our team to support you via remote operation. And further down the line, if your system needs fine tuning or a support issue occurs, we have a simple way of being able to access the system and evaluate the situation.

**LIVE FEED OF
VARIOUS MEASUREMENTS**

**CONTROL YOUR
COMPENSATION SETTINGS**

**HARMONICS
FOR EACH FREQUENCY**



Customer cases from around the world

ADF have been integrated into diverse applications around the world. From data centers in Korea to a Live Fish Carrier in Norway, see how ADF enhances our customers operations.



MARINE

Dutch Royal Navy



Marine projects are always demanding due to strict environmental requirements along with complex power grids. Add a highly sophisticated war ship and you have challenge. Running for several years with traditional static harmonics compensation, one RDN ship began experiencing high harmonics created by the on-board variable frequency drives. ADF with Sensorless Control was retrofitted on board and successfully commissioned during a short trip off the Dutch coast. Due to our extensive experience in the industry and the cost and space-efficiency of ADF, we have become a key supplier of active filters to the marine industry.



WATER & WASTEWATER TREATMENT

Affinity



As pumping stations were upgraded with modernized motor controlling, the plant's demands on power quality increased. Affinity also had a need to meet the G5/4 UK harmonic standard. The ADF system integration concept came in handy, enabling retrofitting on all sites into the existing infrastructure, minimizing downtime and cost.

"A key part of our decision was the superior efficiency of the active harmonic filters compared to the alternative, active front end drives."



AUTOMOTIVE INDUSTRY

BMW



Struggling with harmonics from welding, robotics, and transportation, the BMW plant needed a powerful solution. Taking care of standard harmonic issues, we have also supported with high frequency challenges as well as resonances – applications unique to ADF.

**For the full stories and
more customer cases, visit**

COMSYS.SE



GENERAL INDUSTRY

Sandvik Mining & Rock Technology



The Sandvik operation is dynamic, with high energy demands, requiring an equally dynamic and capable low harmonic solution. While overall Sandvik has experienced improved power quality and productivity, the real showpiece is the enhanced performance of the arc furnace, the power of which increased significantly together with reduced wear and tear.

BERTIL LARSSON, MAINTENANCE MANAGER

“Since our relationship with Comsys started it has evolved over the years and we see them as a long-term strategic partner for power quality. To have a stable, reliable product like ADF is one important factor, the other is the competence and know-how that exists within Comsys and its extensive partner network.”



PARTICLE ACCELERATOR

MAX IV Lab

Building one of the world's most advanced X-ray-based research facilities put high requirements on the quality of the supplied power. Early in the project, Comsys was involved as consultants to help design the part of the grid controlling the power quality. Due to tough requirements and an extremely dynamic load, there was only one solution and very few possible suppliers. With this successful installation we have been awarded several other projects on similar sites as well as hospitals, globally.





DATA CENTERS

LG-CNS



LS Industrial Systems is a Korean powerhouse supplying the industry for more than 40 years. One division under LSIS builds data centers and is today the number one engineering, procurement, and construction company in Korea for new builds. LSIS has implemented several hundred ADF units in several data center projects, ranging from banks

to cloud storage facilities. The outstanding performance and extreme user-friendliness, together with low electrical emissions, are the key factors behind choosing ADF technology for this demanding application involving highly sensitive equipment.



MARINE

Live Fish Carrier

Fitjar Mekaniske Verkstad AS (FMVAS) wanted a proven power quality solution for the Live fish carrier "Seihav", that would help them meet the DNV GL requirement for a THDU limit of 8% and an individual harmonic limit of 5%. With ADF technology, we made sure that FMVAS met the requirements and at the same time we ensured efficient use of the limited space onboard.



ADF Technology is developed by Comsys AB in Lund, Sweden. Working with our global network of partners, the ADF Partner Network provides active filter solutions for a wide range of applications, enabling businesses to increase productivity, and simultaneously save money while reducing their carbon footprint.

Due to the flexibility and adaptability of this low harmonic solution, ADF products are ideal for a wide variety of industries.

www.comsys.se

— COMSYS —